

LUXSTYL
COVER-LIGHT
PROFILES & SKIRTINGS



BOVELACCI

LUXSTYL LED

LE CORNICI PER ILLUMINAZIONE INDIRETTA CON LED

Cornici in polimeri ad altissima densità
 Lunghezza: 2 ml per asta
 Per l'installazione usare: Classicoll Plus, Eurocoll Plus, chiodini in acciaio senza testa e squadretti (pag. 23).
 Temperatura d'impiego: 0° C ÷ +55° C

MOULDINGS FOR LED INDIRECT LIGHTING

HD Polymers covings
 Length: 2 lm.
 For installation use: Classicoll Plus, Eurocoll Plus, steel nails without head and brackets (p. 23).
 Operating temperature: 0° C ÷ +55° C

ZIERPROFILE FÜR INDIREKTE BELEUCHTUNGEN MIT LED

Zierprofile aus HD Polymers
 Länge: 2 Meter.
 Zur Befestigung verwenden Sie: Classicoll Plus-Kleber, Eurocoll Plus-Kleber, Stahlnägel ohne Kopf und Klammern (S. 23)
 Temperatureinsatzbereich: 0° C ÷ +55° C

CORNISAS PARA ILUMINACIÓN INDIRECTA CON LED

Molduras de polimeros
 Longitud: 2 metros
 Para el montaje use: Classicoll Plus, Eurocoll Plus y también clavos de acero sin cabeza y soportes (p. 23).
 Temperatura de uso: 0° C ÷ +55° C

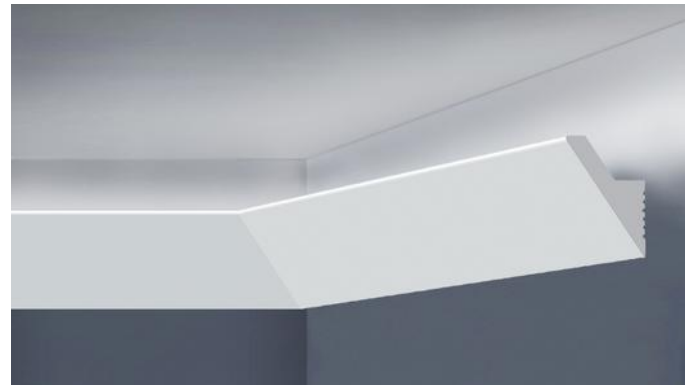
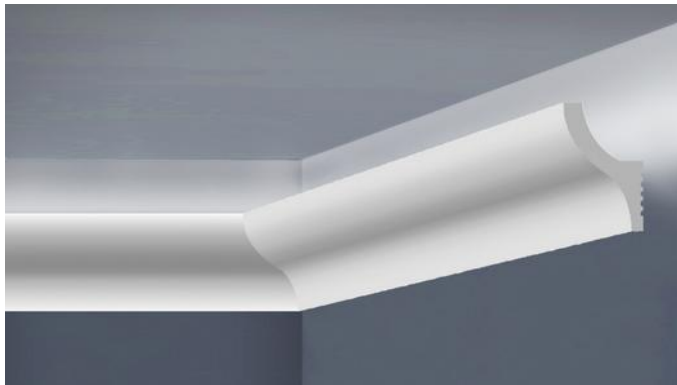

L4530
 ml / conf
 72



8010971449144

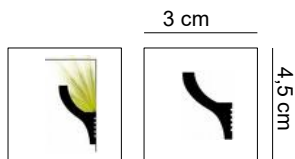

L5535
 ml / conf
 48



8010971449137

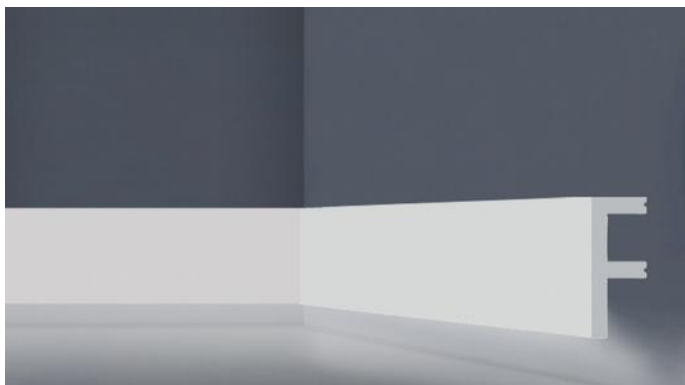
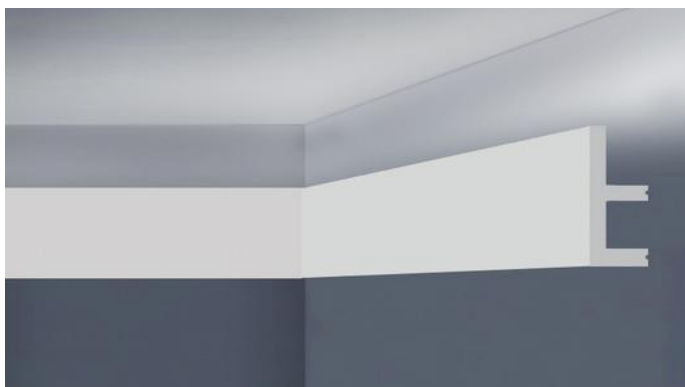

L6024
 ml / conf
 34



8010971449120

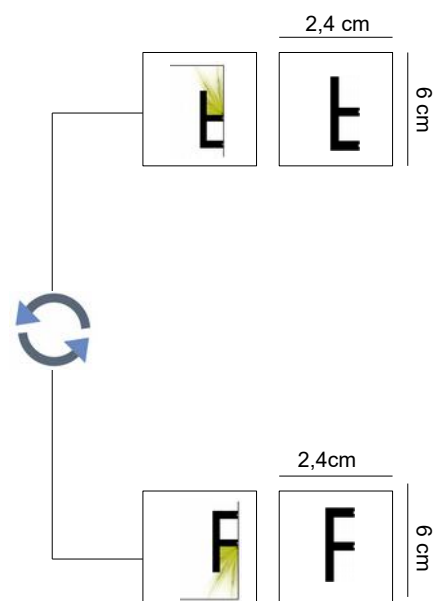

LUXSTYL LED

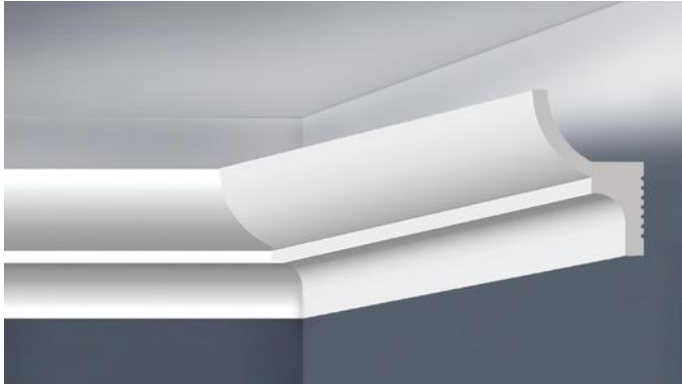

L6537
ml / conf
40

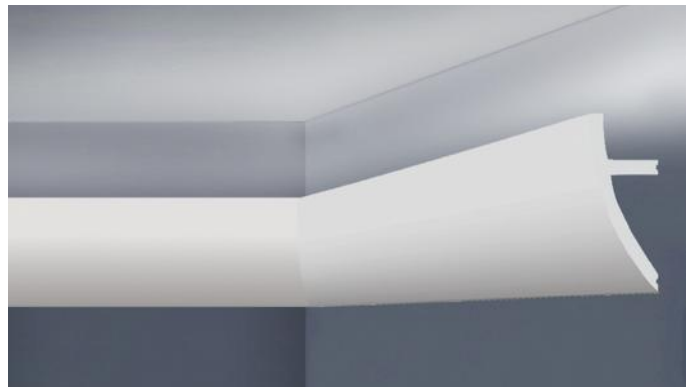
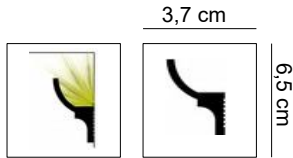

L7033
ml / conf
30

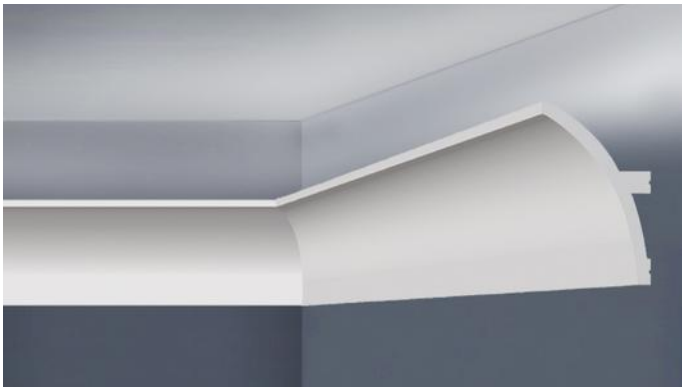
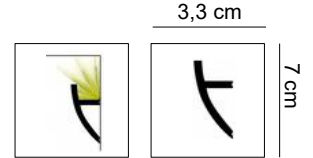

L7556
ml / conf
24

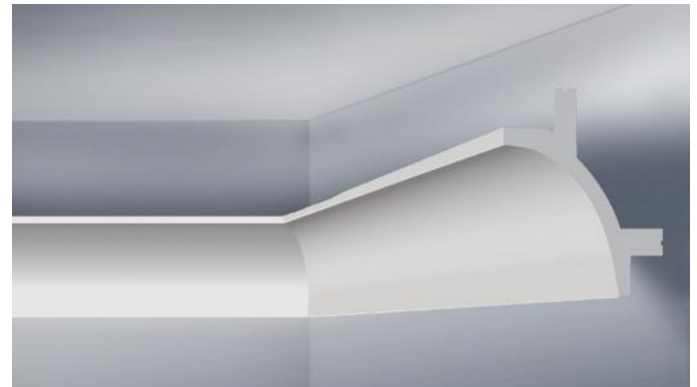
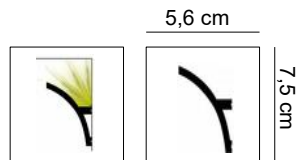

L8585
ml / conf
14

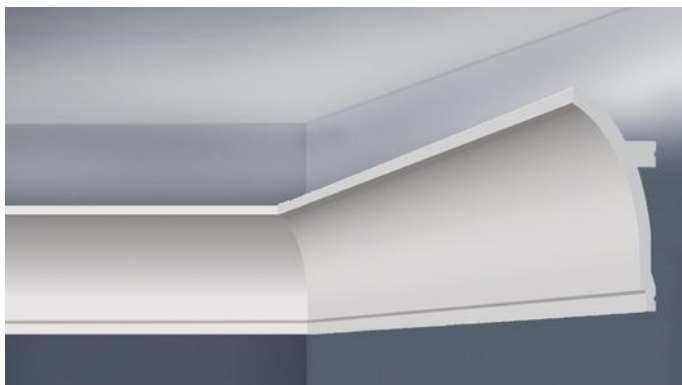
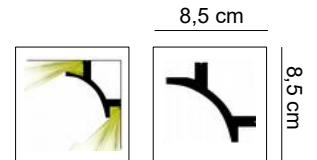

L9548
ml / conf
20

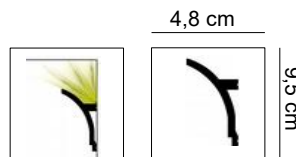

LUXSTYL LED

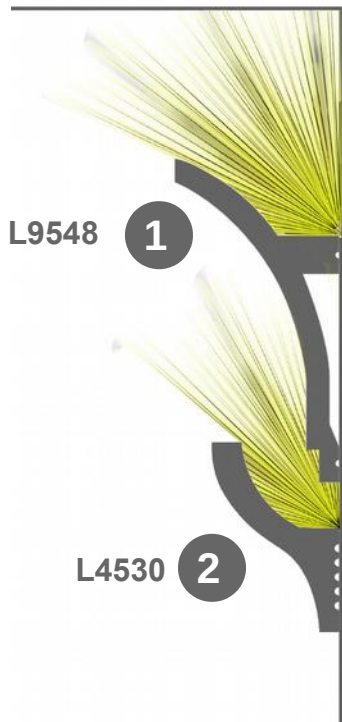

in copertina:

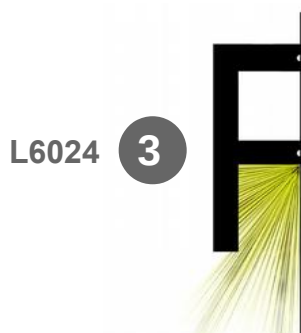
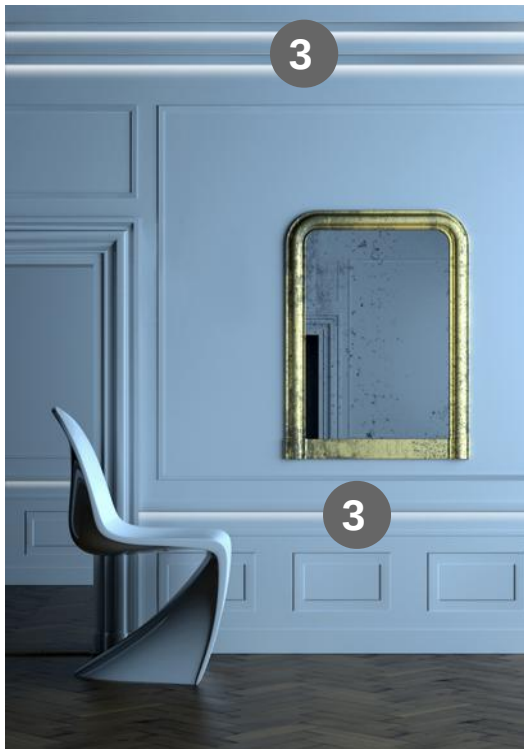



BOVELACCI

LUXSTYL COVER SKIRTINGS

COPRIBATTISCOPA

Copribattiscopa in polimeri ad altissima densità
 Lunghezza: 2 ml per asta
 Per l'installazione usare Classic Coll Plus, Eurocoll Plus, chiodini in acciaio senza testa e squadretti (pag. 23)
 Temperatura d'impiego: 0° C ÷ +55° C

COVER SKIRTINGS

HD Polymers cover skirtings
 Length: 2 lm.
 For installation use Classic Coll Plus, Eurocoll Plus, steel nails without head and brackets (p. 23)
 Operating temperature: 0° C ÷ +55° C

ABDECKUNG SOCKELLEISTE

Abdeckung Sockelleiste aus HD Polymers
 Länge: 2 Meter.
 Zur Befestigung verwenden Sie Classic Coll Plus-Kleber, Eurocoll Plus-Kleber, Stahlnägeln ohne Kopf und Klammern (S. 23).
 Temperatureinsatzbereich: 0° C ÷ +55° C

ZÓCALOS DE CUBIERTA

Zocalos de cubierta de polimeros
 Longitud: 2 metros
 Para el montaje use Classic Coll Plus, Eurocoll Plus y también clavos de acero sin cabeza ysoportes (p. 23).
 Temperatura de uso: 0° C ÷ +55° C

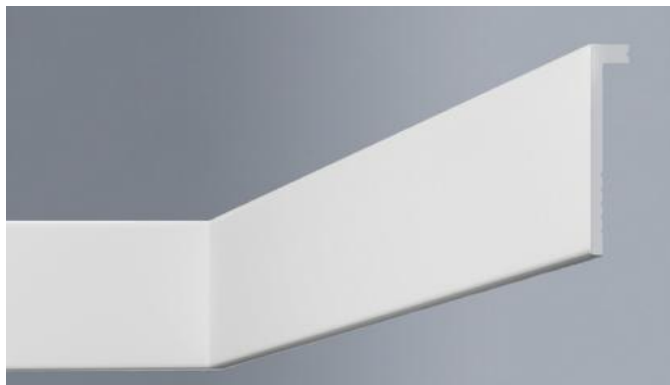

L10020
 ml / conf
 32

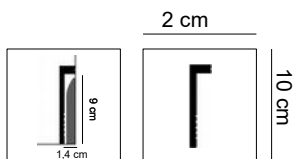

L12022
 ml / conf
 22

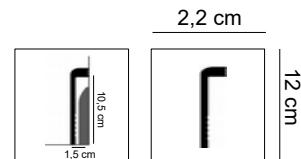

L14020
 ml / conf
 24

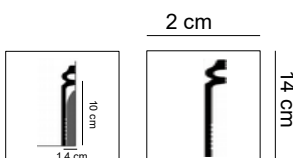

LUXSTYL MULTIFUNCTION PROFILES

PROFILI MULTIFUNZIONE

Profili multifunzione in polimeri ad altissima densità
 Lunghezza: 2 ml per asta
 Per l'installazione usare Classic Coll Plus, Eurocoll Plus, chiodini in acciaio senza testa e squadretti (pag. 23)
 Temperatura d'impiego: 0° C ÷ +55° C

MULTIFUNCTION PROFILES

HD Polymers multifunctional profiles
 Length: 2 lm.
 For installation use Classic Coll Plus, Eurocoll Plus, steel nails without head and brackets (p. 23).
 Operating temperature: 0° C ÷ +55° C

MULTIFUNKTIONS-PROFILE

Multifunktionsprofile aus HD Polymers
 Länge: 2 Meter.
 Zur Befestigung verwenden Sie Classic Coll Plus-Kleber, Eurocoll Plus-Kleber, Stahlnägeln ohne Kopf und Klammern (S. 23).
 Temperatureinsatzbereich: 0° C ÷ +55° C

PERFILES MULTIFUNCIÓN

Perfiles multifunción de polimeros
 Longitud: 2 metros
 Para el montaje use Classic Coll Plus, Eurocoll Plus y también clavos de acero sin cabeza y soportes (p. 23).
 Temperatura de uso: 0° C ÷ +55° C

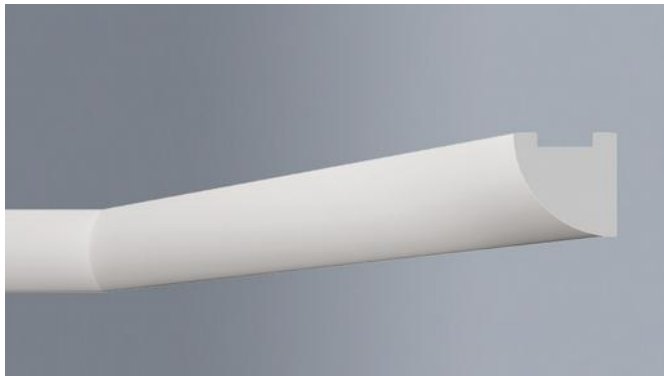

L1818
 ml / conf
 128



8010971450058

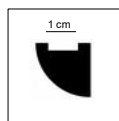
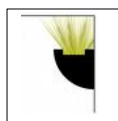

1,8 cm

1,8 cm

L3618
 ml / conf
 80



8010971450027

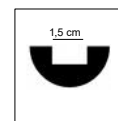

1,8 cm

3,6 cm

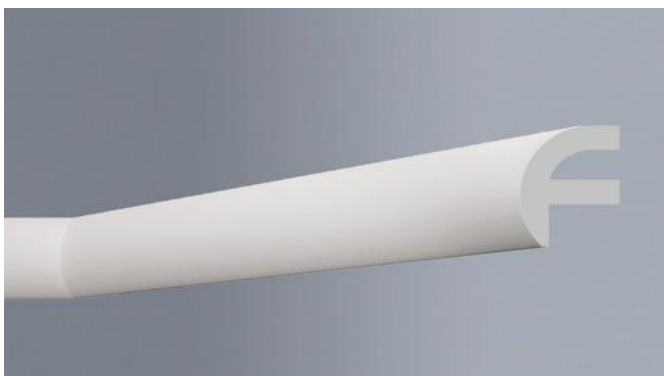

L3125
 ml / conf
 72



8010971450041



2,5 cm

3,1 cm

LUXSTYL SKIRTINGS & PROFILES

BATTISCOPIA E PROFILI

Battiscopa e profili in polimeri ad altissima densità
Lunghezza: 2 ml per asta
Per l'istallazione usare Classic Coll Plus, Eurocoll Plus, chiodini in acciaio senza testa e squadretti (pag. 23).
Temperatura d'impiego: 0° C ÷ +55° C

SKIRTINGS AND PROFILES

HD Polymers skirtings and profiles
Length: 2 lm.
For installation use Classic Coll Plus, Eurocoll Plus, steel nails without head and brackets (p. 23).
Operating temperature: 0° C ÷ +55° C

SOCKELLEISTE UND PROFILE

Sockelleiste und Profile aus HD Polymers
Länge: 2 Meter.
Zur Befestigung verwenden Sie Classic Coll Plus, Eurocoll Plus-Kleber, Stahlnägel ohne Kopf und Klammern (S. 23).
Temperatureinsatzbereich: 0° C ÷ +55° C

ZÓCALOS Y PERFILES

Zocalos y perfiles de polimeros
Longitud: 2 metros
Para el montaje use Classic Coll Plus, Eurocoll Plus y también clavos de acero sin cabeza y soportes (p. 23).
Temperatura de uso: 0° C ÷ +55° C



L2510 (fronte)
ml / conf
140



8010971450034

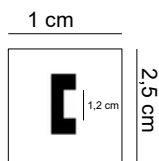

L2510 (retro)
ml / conf
140



8010971450034

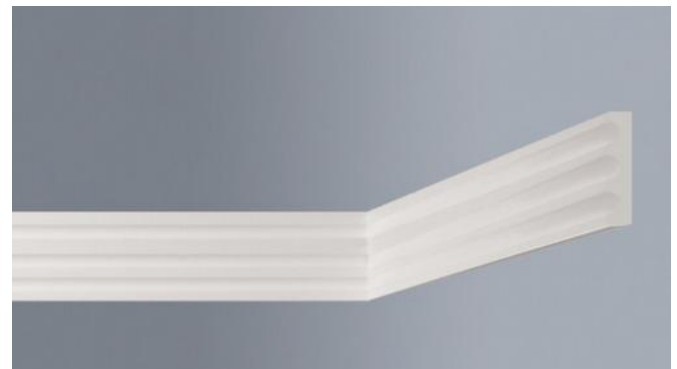
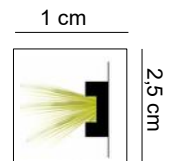

L5010 (fronte)
ml / conf
76



8010971450010

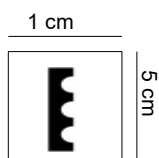

L5010 (retro)
ml / conf
76



8010971450010

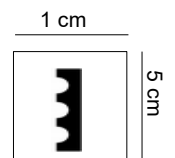

LUXSTYL SKIRTINGS & PROFILES



L6513 - NW65

ml / conf
48



8010971449694

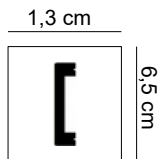

L7015 - NW70

ml / conf
44



8010971449984

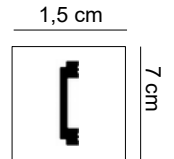

L7115

ml / conf
44



8010971450768

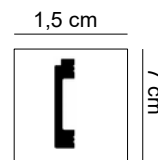

L759 - NF75

ml / conf
64



8010971449960



L7512

ml / conf
44



8010971449595

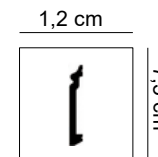

L7514

ml / conf
46



8010971449588

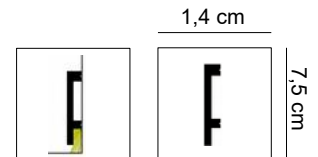



■ L10015

LUXSTYL SKIRTINGS & PROFILES



L7515 - NW75

ml / conf
44



1,5 cm



7,5 cm



L8012 - NF80

ml / conf
40



1,2 cm

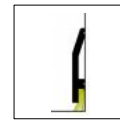

8 cm



L8512 - NF85

ml / conf
48



1,2 cm

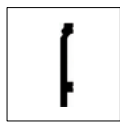
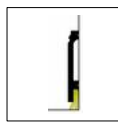

8,5 cm



■ L10014

LUXSTYL SKIRTINGS & PROFILES



L9510 (fronte)

ml / conf

44



8010971450003

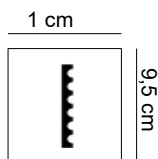

L9510 (retro)

ml / conf

44



8010971450003

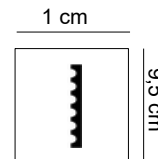

L10014 - NF99

ml / conf

36



8010971449953



L10015 - NF100

ml / conf

28



8010871449632

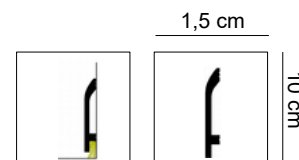

L10515 - NF110

ml / conf

28



8010971449991

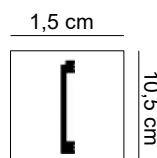

L11014 - NF108

ml / conf

32



8010971449946

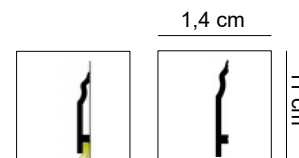

LUXSTYL SKIRTINGS & PROFILES



L11813 - NF118

ml / conf
26



8010871449649

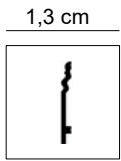
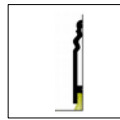

L12514 - NL125

ml / conf
28



8010871449687

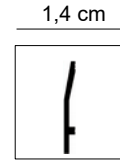
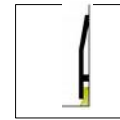

■ L5010

■ L2510

■ L12514

LUXSTYL SKIRTINGS & PROFILES

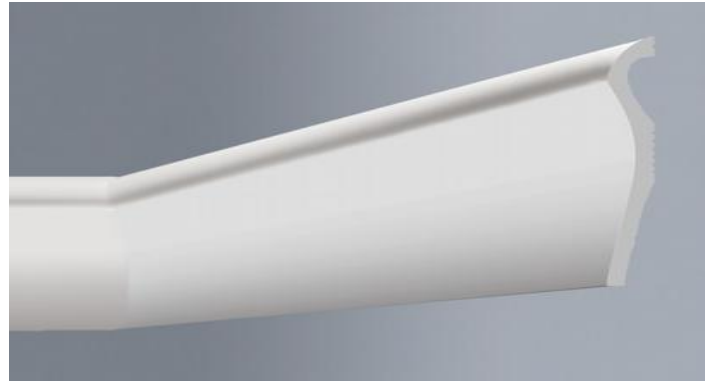

L12515 - NF125

ml / conf
22



8010871449656

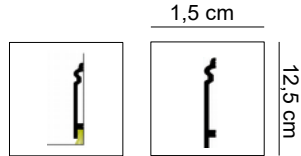

L12517

ml / conf
26



8070971449939

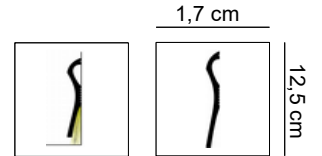

■ L12515

LUXSTYL SKIRTINGS & PROFILES



L13016 - NF130

ml / conf
26



8010971449922

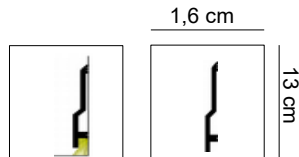

L14015 - NF140

ml / conf
20



8010971449663

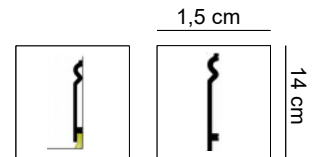

■ L13016

LUXSTYL SKIRTINGS & PROFILES



L14817 - NW148

ml / conf
18



8010871449700

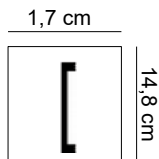

L14915 - NF149

ml / conf
20



8010871449670

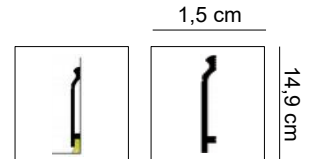

L15015 - NF150

ml / conf
22



8010971449915

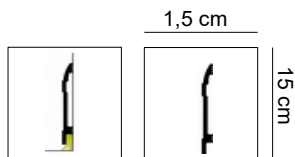

LUXSTYL DADO RAILS

CORNICI PER PARETI E SOFFITTI

Cornici per pareti e soffitti in polimeri ad altissima densità
Lunghezza: 2 ml per asta
Per l'installazione usare Classic Coll Plus, Eurocoll Plus, chiodini in acciaio senza testa e squadretti (pag. 23).
Temperatura d'impiego: 0° C ÷ +55° C

DADO RAILS

HD Polymers dado rails and profiles
Length: 2 lm.
For installation use Classic Coll Plus, Eurocoll Plus, steel nails without head and brackets (p. 23).
Operating temperature: 0° C ÷ +55° C

WANDPROFILE

Wandprofile und Profile aus HD Polymers
Länge: 2 Meter.
Zur Befestigung verwenden Sie Classic Coll Plus-Kleber, Eurocoll Plus-Kleber, Stahlnägeln ohne Kopf und Klammern (S. 23).
Temperatureinsatzbereich: 0° C ÷ +55° C

MOLDURAS DE PARED Y TECHO

Zocalos y perfiles de polimeros
Longitud: 2 metros
Para el montaje use Classic Coll Plus, Eurocoll Plus y también clavos de acero sin cabeza y soportes (p. 23).
Temperatura de uso: 0° C ÷ +55° C

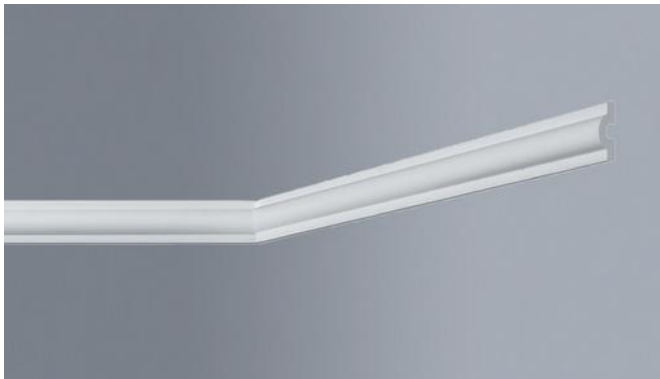

L209 - A02D

ml / conf
254



8010971450959

0,9 cm

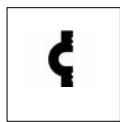

2 cm



L2411 - A03D

ml / conf
192



8010971450966

1,1 cm



2,4 cm

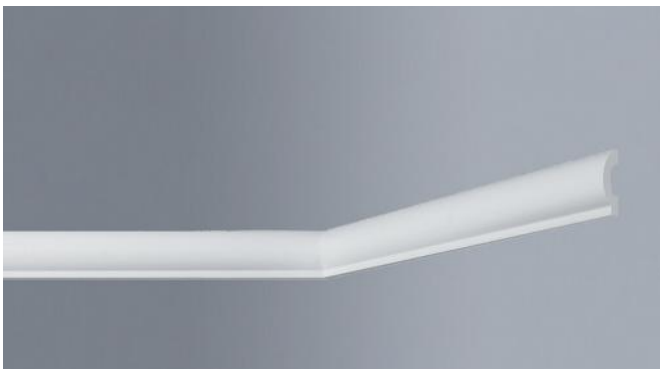

L3010 - A01D

ml / conf
168



8010971450973

1 cm



3 cm



L3515 - A35W

ml / conf
90



8010971450980

1,5 cm

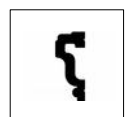

3,5 cm

LUXSTYL DADO RAILS



L3919 - A10W

ml / conf

80



8010971450997

1,9 cm

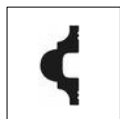

3,9 cm

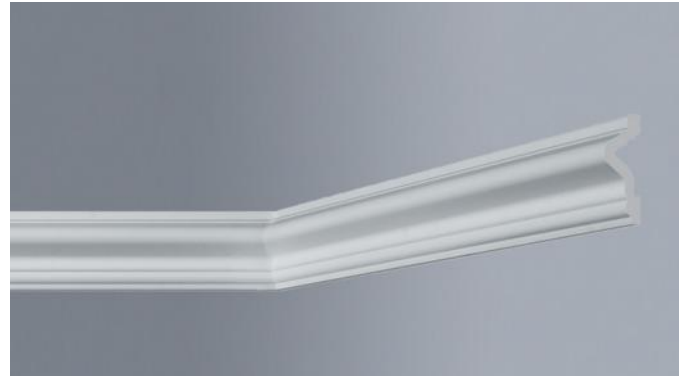

L4620 - A46W

ml / conf

64



8010971451000

2 cm

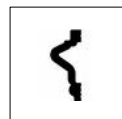

4,6 cm

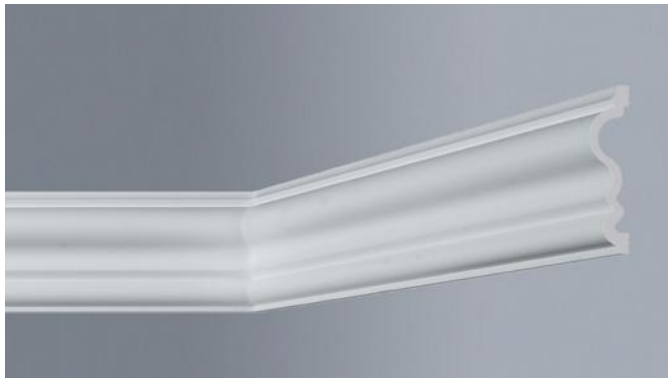

L7020 - A70W

ml / conf

40



8010971451031

2 cm



7 cm

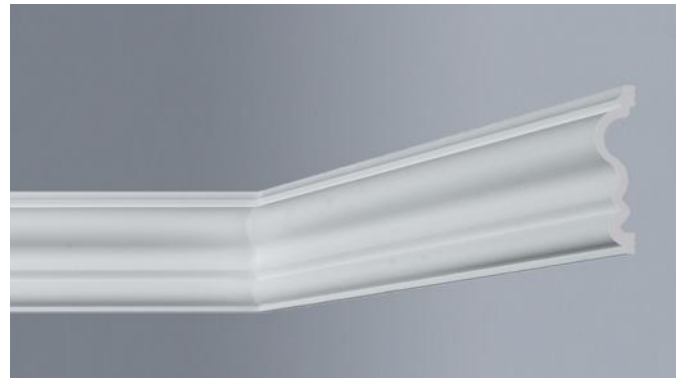

L8020 - A13W

ml / conf

32



8010971451017

2 cm

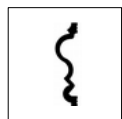

8 cm

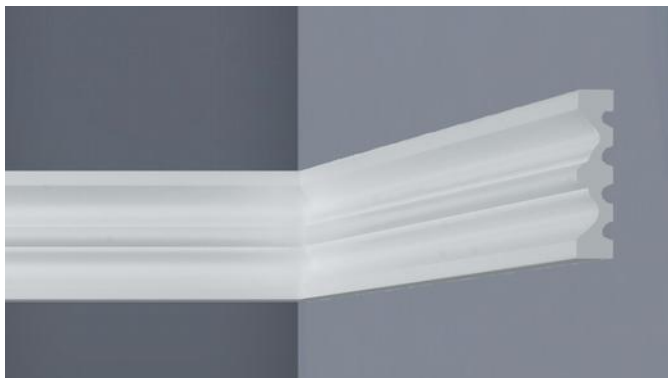

L9018 - A90P (fronte)

ml / conf

24



8010971451055

1,8 cm

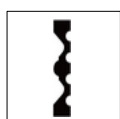

9 cm

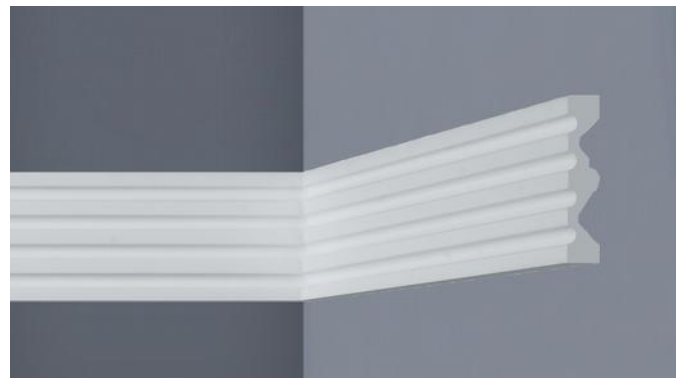

L9018 - A90P (retro)

ml / conf

24



8010971451055

1,8 cm

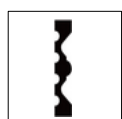

9 cm

LUXSTYL DADO RAILS



L918 – A91W (fronte)
ml / conf
42



8010971451024

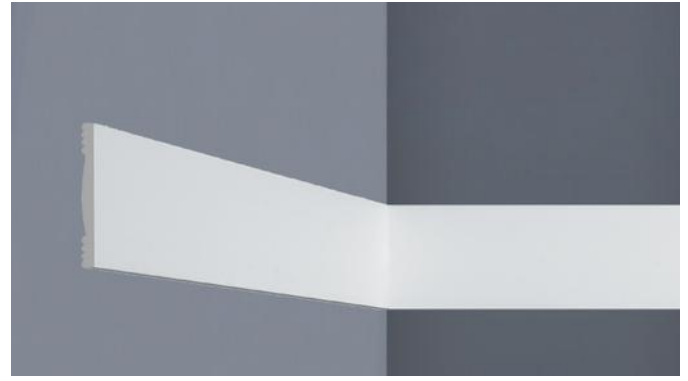
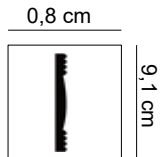

L918 – A91W (retro)
ml / conf
42



8010971451024

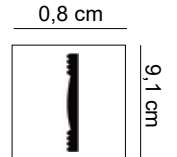

LUXSTYL COVINGS

CORNICI PER SOFFITTI

Cornici per soffitti in polimeri ad altissima densità
Lunghezza: 2 ml per asta
Per l'installazione usare Classic Coll Plus, Eurocoll Plus, chiodini in acciaio senza testa e squadretti (p. 23).
Temperatura d'impiego: 0° C ÷ +55° C

CEILING COVINGS

HD Polymers ceiling covings
Length: 2 lm.
For installation use Classic Coll Plus, Eurocoll Plus, steel nails without head and brackets (p. 23).
Operating temperature: 0° C ÷ +55° C

ECKEPROFILE

Eckeprofile aus HD Polymers
Länge: 2 Meter.
Zur Befestigung verwenden Sie Classic Coll Plus-Kleber, Eurocoll Plus-Kleber, Stahlnägeln ohne Kopf und Klammern (S. 23).
Temperatureinsatzbereich: 0° C ÷ +55° C

MOLDURAS DE TECHO

Molduras de techode polimeros
Longitud: 2 metros
Para el montaje use Classic Coll Plus, Eurocoll Plus y también clavos de acero sin cabeza y soportes (p. 23).
Temperatura de uso: 0° C ÷ +55° C

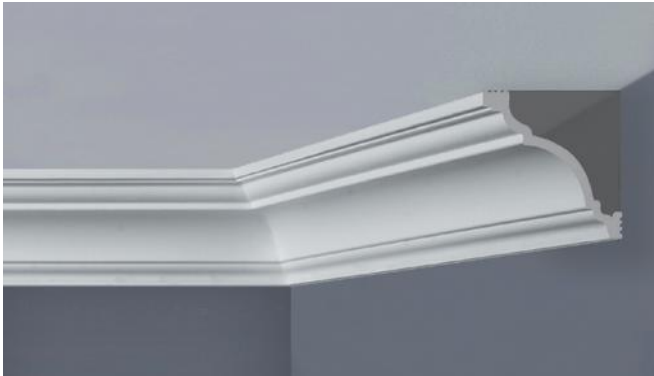

L8080 - A19C

ml / conf
24



8010971451048

8 cm

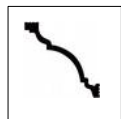

8 cm



L90120 - A17C

ml / conf
18



8010971451079

12 cm

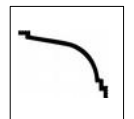

9 cm



L100100 - A04C

ml / conf
18



8010971451086

10 cm



10 cm



L11793 - A20C

ml / conf
14



8010971451062

9,3 cm



11,7 cm

LUXSTYL COVINGS

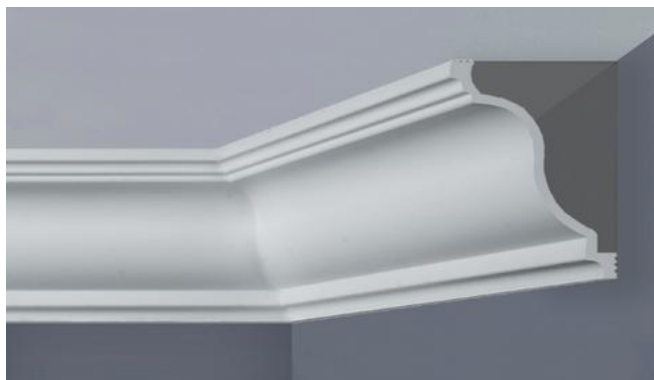

L130113 - A22C

ml / conf

16

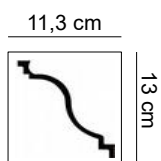

■ L10515

■ L14817



DDL
Display
Luxstyl per LED

pz / conf
1



8010971449878



DTOL
Totem 5 lati

pz / conf
1



DDLPL
Display
Luxstyl

pz / conf
1 (5 parti)

LE ISTRUZIONI PER IL MONTAGGIO

È preferibile posare le cornici prima di tappezzare le pareti. I prodotti devono essere applicati su pareti asciutte, pulite e sgrassate. Sono sufficienti i seguenti accessori: cassetta per taglio, sega speciale Bovelacci, Classic Coll Plus, Eurocoll Plus, spatola, spugna, pittura, pennelli, cutter e metro.

ASSEMBLING INSTRUCTIONS

We suggest to install mouldings before wallpapering. Items must be applied on dry clean and ungreased surfaces. You need only the following tools: mitre-box, Bovelacci special saw, glue Classic Coll Plus, Eurocoll Plus, spatula, sponge, paint, brush, cutter and metre.

VERARBEITUNGSTIPS

Wir empfehlen die Zierprofile nach Möglichkeit vor den Tapezierarbeiten zu verkleben. Der Untergrund muss saugfähig, sauber, trocken und staubfrei sein. Folgende Werkzeuge werden benötigt: Gehrungslade, Bovelacci-Speziialsäge, Classic Coll Plus-Klebstoff, Eurocoll Plus-Klebstoff, Spachtel, Schwamm, Farbe, Pinsel, Cuttermesser und ein Zollstock.

INSTRUCCIONES DE MONTAJE

Es preferible colocar las molduras antes de empapelar las paredes. Los productos deben aplicarse sobre paredes secas, limpias y desengrasadas. Los siguientes accesorios son suficientes: caja de corte, sierra especial Bovelacci, Classic Coll Plus, Eurocoll Plus, espátula, esponja, pintura, pinceles, cúter y cinta métrica.



LE ISTRUZIONI PER IL MONTAGGIO DEI PROFILI

PROFILES ASSEMBLING INSTRUCTIONS

VERARBEITUNGSTIPS: PROFILE

INSTRUCCIONES DE MONTAJE DE LOS PERFILES

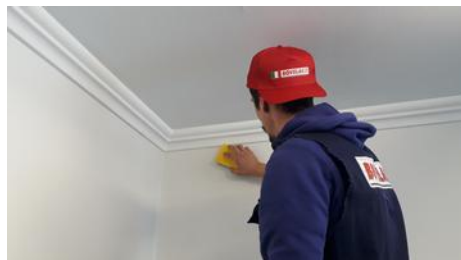
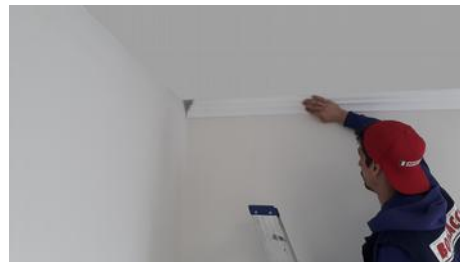

1. Iniziare a tagliare i profili in modo da realizzare gli angoli che vi servono. Controllate che combinino.

2. Stendere la colla speciale Classic Coll Plus. Per stuccare o eventualmente incollare su superficie assorbente utilizzare Eurocoll Plus (temperatura di applicazione da +8°C a +30°C) su entrambe le superfici posteriori dell'asta che andranno a contatto con la parete o il soffitto, nonché fra le giunture (incidenza media: 1 cart. x 8 ml). Utilizzare chiodini in acciaio ogni 40 cm.

3. Applicare il profilo alla parete con una leggera pressione. Per stuccare, dopo una settimana, riempire con Eurocoll Plus ogni giuntura o spazio.

4. Togliere l'eccesso di colla con l'aiuto di una spatola o di un cutter.

5. Pulire con una spugna umida.

6. Lasciare asciugare poi rifinite con pittura a base d'acqua.

7. **Per luci LED:** prima dell'installazione verniciare il retro delle cornici con pittura a base d'acqua di colore nero.

1. Cut straight ends to make the type of corners you need. Check fit.

2. Apply the special glue Classic Coll Plus. To fill the joints or to glue on absorbent surface use Eurocoll Plus (application temperature from +8°C to +30°C) meant to lean on the wall and inside the joint (average incidence: 1 cart. x 8 ml). Use steel nails every 40 cm.

3. Press pieces into the corner with a light pressure. After a week fill all joints and gaps with Eurocoll Plus.

4. Remove glue in excess by using a spatula or a cutter.

5. Wipe smooth with a clean damp sponge.

6. Let dry and then apply water-based paint.

7. **For LED lights:** before installation, paint the back of the mouldings with black water-based paint.

1. Beim Schneiden der Gehrung ist unbedingt darauf zu achten, dass die "Deckenklebefläche" des Profils auf dem Boden und die "Wandklebefläche" an der Innenwand der Gehrungslade liegt.

2. Nachdem die Gehrung auf Passgenauigkeit geprüft wurde, wird der Klebstoff Classic Coll Plus oder Eurocoll Plus (für saugfähige Unterlagen) (Verbrauchstemperatur +8°C +30°C) auf beide Klebeflächen und im Stoßbereich mit der Kartusche oder mit dem Spachtel aufgetragen (durchschnittlicher Verbrauch: 1 Kart. x 8 ml). Befestigen mit Stahlnägeln alle 40 cm.

3. Das Profil passgenau ansetzen und vorsichtig andrücken. Nach einer Woche alle Fugen und Stöße mit Eurocoll Plus füllen.

4. Überschüssigen Klebstoff mit einem Spachtel oder einem Cuttermesser sofort entfernen.

5. Anschließend Klebstoffreste mit einem feuchten Schwamm sofort abwaschen.

6. Die Zierprofile können nach der Trocknungszeit mit Dispersionsfarbe oder Acryllack überstrichen werden.

7. **Bei LED-Leuchten:** Vor der Verarbeitung die Rückseite der Zierleiste mit schwarzer Farbe auf Wasserbasis streichen

1. Cortar los perfiles para obtener los ángulos que necesita. Asegurarse que combinen.

2. Aplicar el adhesivo especial Classic Coll Plus. Para enmasillar o pegar sobre soporte absorbente utilizar Eurocoll Plus (temperatura de aplicación de + 8°C a + 30°C) en ambas las superficies posteriores de las varillas que se pegarán a la pared o al techo y entre las juntas. (incidencia media: 1 cartucho x 8 ml). Usar clavos de acero cada 40 cm.

3. Presionar levemente el perfil a la pared. Para enmasillar o después de una semana sellar cada junta y espacio con Eurocoll Plus.

4. Quitar el exceso de cola con una espátula o un cúter.

5. Limpiar con ayuda de una esponja limpia y húmeda.

6. Dejar que seque y luego terminar con pintura a base de agua.

7. **Para luces LED:** antes de la instalación, pinte la parte posterior de las molduras con pintura negra a base de agua.



BOVELACCI

BOVELACCI SRL
Via del Commercio, 5
47122 Forlì – Italy
Tel. +39 0543 811611
Fax +39 0543 72127

www.bovelaccidecor.com
bovelacci@bovelacci.it

